



TRINIDAD AND TOBAGO GAZETTE

VOL. 41

Port-of-Spain, Trinidad, Thursday 24th October, 2002—Price \$1.00

No. 202

No.	GAZETTE NOTICE	PAGE	No.	GAZETTE NOTICE	PAGE
2148	Claims against Estate of deceased person ...	7975	2152	Central Bank, Weekly Statement of Account as at 16th October, 2002	7981
2149	Adoption by the Teaching Service Commission of Amendments to the Public Service Commission Regulations	7975	2153	National Lottery Draw No. 965—Results ...	7982
2150	The Council of the National Trust of Trinidad and Tobago—Notice of Intention to list Properties	7976	2154	National Lottery Draw No. 966—Notice ...	7982
2151	Probate and Letters of Administration—Applications	7977	2155-60	Patents	7984
			2161	Proposals for Consulting Services for the Design of a Supply/Substitute Teacher System for the Ministry of Education under the Secondary Education Modernization Programme (SEMP)—IDB Loan No. 1180/OC-TT	7990

2148

REPUBLIC OF TRINIDAD AND TOBAGO

In the Estate of

AILEEN MARIE DE VERTEUIL also called AILEEN DE VERTEUIL—*Deceased*
Widow of 13, Rostant Street, St. Joseph Village, San Fernando, Trinidad

NOTICE is hereby given that creditors and other persons having claims against, or an interest in the Estate of the above-named deceased should give notice in writing to Messrs. J. D. Sellier and Company, 129–131, Abercromby Street, Port-of-Spain, Trinidad, who are Attorneys-at-law for Hugh Gransaul and John Gransaul, the Executors named in the Will of the above-named deceased, not later than the 24th day of November, 2002 after which date the said Hugh Gransaul and John Gransaul intend to distribute the Estate of the deceased among the parties entitled thereto having regard only to the claims of which notice has been received by the said Attorneys-at-law.

Dated this 17th day of October, 2002.

J. D. SELLIER AND COMPANY
*Attorneys-at-law for Hugh Gransaul and John Gransaul
the Executors named in the Will of the late
Aileen Marie De Verteuil also called Aileen De Verteuil*

2149

ADOPTION BY THE TEACHING SERVICE COMMISSION OF AMENDMENTS TO THE PUBLIC SERVICE COMMISSION REGULATIONS

IT IS NOTIFIED for general information that the Teaching Service Commission, with the consent of the Prime Minister, has adopted *mutatis mutandis*, the following amendments to the Public Service Commission Regulations:

- (a) the Public Service Commission (Amendment) Regulations, 1991—Legal Notice No. 28 of 1991—Regulation 2(g) only;
- (b) the Public Service Commission (Amendment) Regulations, 1998—Legal Notice No. 238 of 1998; and
- (c) the Public Service Commission (Amendment) Regulations, 2000—Legal Notice No. 173 of 2000.

These regulations with the words “Teaching Service Commission” substituted for the words “Public Service Commission” wherever those words occur therein, will continue to apply to members of the Teaching Service until further notice.

L. BIRMINGHAM
*Chairman,
Teaching Service Commission*

2150

THE COUNCIL OF THE NATIONAL TRUST OF TRINIDAD AND TOBAGO—NOTICE OF INTENTION
TO LIST PROPERTIES

(National Trust of Trinidad and Tobago Act, 1991)

NOTICE is hereby given that the Council of the National Trust of Trinidad and Tobago in exercise of the powers conferred on it—

- (a) by Regulation 5 of the National Trust of Trinidad and Tobago Regulations, intends to list the properties specified in the second and third columns of the Schedule to this notification; and
- (b) by Regulation 2(4)(b), grades the properties as set out in the fourth column of the said Schedule.

SCHEDULE

<i>No.</i>	<i>Title of Property</i>	<i>Description of Lands</i>	<i>Grade</i>
1.	Ambard's House-Roomor (Part of the Magnificent Seven historic district)	Parcel of land in the City of Port-of-Spain comprising forty-three thousand, seven hundred and ten square feet, bounded on the north by Flood Street, on the south by Lot No. 23—Mille Fleurs, on the east by Maraval Road and on the west by a sewer reserve.	1
2.	Archbishop's Palace (Part of the Magnificent Seven historic district)	Parcel of land in the City of Port-of-Spain comprising forty-three thousand, seven hundred and ten square feet, bounded on the north by Lot No. 29—Rosenwek now Whitehall, on the south by Flood Street, on the east by Maraval Road and on the west by a sewer reserve.	1
3.	Hayes Court (Part of the Magnificent Seven historic district)	Parcel of land in the City of Port-of-Spain comprising forty-three thousand, seven hundred and ten square feet, bounded on the north by Lot No. 23—Mille Fleurs, on the south by Hayes Street, on the east by Maraval Road and on the west by a sewer reserve.	1
4.	Killarney—Stollmeyer's Castle (Part of the Magnificent Seven historic district)	Parcel of land in the City of Port-of-Spain comprising forty-three thousand, seven hundred and ten square feet, bounded on the north by Serpentine Road, on the south by Lot No. 29—Rosenwek now Whitehall, on the east by Maraval Road and on the west by a sewer reserve.	1
5.	Mille Fleurs (Part of the Magnificent Seven historic district)	Parcel of land in the City of Port-of-Spain comprising forty-three thousand, seven hundred and ten square feet, bounded on the north by Lot No. 25—Ambard's House, on the south by Lot No. 21—Hayes Court, on the east by Maraval Road and on the west by a sewer reserve.	1
6.	Queen's Royal College (Part of the Magnificent Seven historic district)	Parcel of land in the City of Port-of-Spain, bounded on the north by Hayes Street, on the south by St. Clair Avenue, on the east by Maraval Road and on the west by the Ministry of Education.	1
7.	Rosenwek—Whitehall (Part of the Magnificent Seven historic district)	Parcel of land in the City of Port-of-Spain comprising forty-three thousand, six hundred and thirty-four superficial feet, bounded on the north by Lot No. 31—Stollmeyer's Castle, on the south by Lot No. 27—Archbishop's Palace, on the east by Maraval Road and on the west by a sewer reserve.	1

Dated this 17th day of October, 2002.

V. LEWIS
Chairman,
Council of the National Trust of
Trinidad and Tobago

2151

PROBATE AND LETTERS OF ADMINISTRATION

PUBLIC NOTICE is hereby given that applications have been made for the following grants of Probate and/or Letters of Administration:

LETTERS OF ADMINISTRATION of the estate of LENARD TAYLOR of Building 14, Apartment 2-3 East, Maloney Gardens, d'Abadie, Arima, Trinidad, who died on the 6th day of September, 1994, by THE ADMINISTRATOR GENERAL OF TRINIDAD AND TOBAGO;

LETTERS OF ADMINISTRATION of the estate of MATHILDA MARCANO otherwise MATILDA MARCANO otherwise MATHILDA PIPER otherwise MATHILDA FRANCOIS otherwise SALLY PIPER of Sandale Avenue, Diego Martin, Trinidad, who died on the 3rd day of December, 1980, by CECILIA NELSON otherwise HYACINTHA NELSON of Gopaul Avenue, Diego Martin, Trinidad, her daughter and the only person entitled to the estate;

LETTERS OF ADMINISTRATION with Will dated the 5th day of May, 1982, annexed of WINNIFRED ALLEYNE otherwise WINIFRED ALLEYNE otherwise WINNIFRED AGATHA CLARKE otherwise WINIFRED CLARKE of 4, Upper Pashley Street, Laventille, St. Ann's, Trinidad, who died on the 20th day of June, 1996, by CHERYL-ANN BAPTISTE of the same place, one of the residuary devisees and/or legatees named in the Will;

LETTERS OF ADMINISTRATION of the estate of SIEW BOODOORAM of 2¹/₄ Mile Mark, Lopinot Road, Arouca, Tacarigua, Trinidad, who died on the 11th day of November, 1989, by INDRAMATIE BOODOORAM of the same place, his lawful widow and relict;

LETTERS OF ADMINISTRATION of the estate of GEORGE ANDERSON GRIMSHAW otherwise GEORGE GRIMSHAW of 71, Caspian Core South, Westmoorings by-the-Sea, Carenage, Diego Martin, Trinidad, who died on the 23rd day of October, 1998, by RAMONA BARBARA GRIMSHAW otherwise RAMONA GRINSHAW of the same place, his lawful widow and relict;

PROBATE of the Will dated the 7th day of August, 1988, of ELLIS CHEDDIE otherwise ELLIS RODERICK CHEDDIE SOOKDEO of Light Pole No. 21, No. 6 Dubarry Trace, Delhi Road, Fyzabad, Siparia, Trinidad, who died on the 29th day of June, 2001, by MONA CHEDDIE of the same place, widow, relict of deceased, the sole executrix named in the Will;

LETTERS OF ADMINISTRATION of the estate of RALPH GAYAH of Light Pole No. 5, Campbell Street, Cedros, Trinidad, who died on the 2nd day of April, 2001, by MONEE GAYAH of the same place, his lawful widow and relict;

LETTERS OF ADMINISTRATION of the estate of ROOPNARINE GOBIN of 7A, Cippy Street, Charles Street, Gasparillo, Pointe-a-Pierre, Trinidad, who died on the 1st day of August, 2001, by KENNY BOODRAM ROOPNARINE of the same place, his son and one of the persons entitled to share in the estate;

PROBATE of the Will dated the 7th day of November, 2000, of CONSILA JAGNARINE otherwise CONSICALLA JAGNARINE otherwise KOWSIL RAMBARAN otherwise CONSICALA JAGNARINE otherwise COUNSILLIA RAMBERAN of 25, Thompson Street, Gasparillo, Pointe-a-Pierre, Trinidad, who died on the 16th day of November, 2000, by SHIRLEY JAGNARINE of 82, Samaan Drive, Homeland Gardens, Cunupia, Trinidad, grandson of deceased, the sole executor named in the Will;

LETTERS OF ADMINISTRATION of the estate of DEO JAGESSAR of West Macaulay Park, Dow Village New Settlement, California, Couva, Trinidad, who died on the 28th day of April, 1984, by RADICA JAGESSAR of the same place, his lawful widow and relict;

PROBATE of the Will dated the 16th day of April, 1993, of BALROOP RAMSARAN of 3¹/₂ Mile Mark, Guaico-Tamana Road, Cunaripo, Tureure, Trinidad, who died on the 24th day of January, 2000, by COOPCHAN RAMSARAN of the same place, son of deceased, the sole executor named in the Will;

LETTERS OF ADMINISTRATION of the estate of ALWYN RAPHAEL otherwise ALWIN THOMAS CANTERBURY RAPHAEL otherwise ALWIN RAPHAEL otherwise ALVIN RAPHAEL of Light Pole No. 30, Pinto Road, Arima, Trinidad, who died on the 5th day of September, 2000, by PAMELA RAPHAEL otherwise PAMELA HETHER ALBERTINA RAPHAEL of Light Pole No. 10, Sellier Trace, Ojoe Road, Sangre Grande, Manzanilla, Trinidad, his lawful daughter and one of the next of kin;

LETTERS OF ADMINISTRATION with Will dated the 25th day of April, 2000, annexed of WYNLEIGH CLARKE otherwise JOHN WYNLEIGH CLARKE of 15, Lashley Street, Tunapuna, Tacarigua, Trinidad, who died on the 9th day of October, 2001, by GISELLE RIMA CLARKE of the same place, daughter of deceased, one of the residuary devisees and/or legatees named in the Will;

PROBATE of the Will dated the 22nd day of November, 2000, of LEONORA DE LISLE otherwise LEONORA JOSSE DE LISLE of 13, Coblenz Avenue, Cascade, St. Ann's, Trinidad, who died on the 10th day of January, 2001, by IAN JOSSE DE LISLE of the same place, son of deceased, the sole executor named in the Will;

2151—Continued

PROBATE AND LETTERS OF ADMINISTRATION—CONTINUED

- LETTERS OF ADMINISTRATION of the estate of ELSA PIERRE otherwise OCTAVIA PIERRE otherwise ELSA OCTAVIA PIERRE of 84, George Karim Avenue, Sangre Grande, Manzanilla, Trinidad, who died on the 12th day of April, 2002, by RAYMOND PIERRE of the same place, her son and one of the persons entitled to share in the estate;
- LETTERS OF ADMINISTRATION of the estate of BHAIO JAGASSAR otherwise BHAIO RADA JAGASAR of Light Pole No. 5, Cumuto Main Road, Cumuto, Tamana, Trinidad, who died on the 7th day of March, 2002, by AUTRA JEAN JAGASAR of the same place, his lawful widow and relict;
- PROBATE of the Will dated the 13th day of April, 1995, of ROSAMUND VERONICA DAVIDSON otherwise ROSAMUND DAVIDSON of 5, Foster Drive, La Pastora, Santa Cruz, St. Ann's, Trinidad, who died on the 9th day of June, 2002, by EVERARD DERRICK DAVIDSON otherwise EVERARD DAVIDSON of 7, Sobrian Street, Siparia, Trinidad, son of deceased, the sole executor named in the Will;
- PROBATE of the Will dated the 20th day of July, 1995, of SITAZ HASSANALI of 19, Cocoapiece Road, Bon Aventure Village, Gasparillo, Pointe-a-Pierre, Trinidad, who died on the 1st day of August, 1999, by SUMINTRA HASSANALI of the same place, widow, relict of deceased, the sole executrix named in the Will;
- LETTERS OF ADMINISTRATION of the estate of SANMATIE ROOPSINGH otherwise RAMDULARIE ROOPSINGH otherwise RAMDOLARIE ROOPSINGH of 15, Baker Trace, Guaico, Tamana, Trinidad, who died on the 26th day of January, 2001, by TOOLARIE SUSAN ROOPSINGH of the same place, her lawful daughter and one of the next of kin;
- LETTERS OF ADMINISTRATION of the estate of FAZILA RAMKISSOON of Baboolal Trace, Sangre Chiquito, Sangre Grande, Manzanilla, Trinidad, who died on the 14th day of May, 2001, by TWALIB HOSEIN of 173, Eastern Main Road, Sangre Grande, Manzanilla, Trinidad, her brother and the only person entitled to the estate;
- LETTERS OF ADMINISTRATION of the estate of ASHRAF ALI of 2, Iere Village, Princes Town, Savana Grande, Trinidad, who died on the 18th day of June, 2002, by CHERYL ABLACK ALI of the same place, his lawful widow and relict;
- LETTERS OF ADMINISTRATION of the estate of SONNILAL KISSOON of 164, Jaipaulsingh Road, Lengua, Barrackpore, Naparima, Trinidad, who died on the 21st day of April, 2002, by LATCHMIN KISSOON of the same place, his lawful widow and relict;
- LETTERS OF ADMINISTRATION of the estate of EARL STEADMAN of 335, Caratal Road, Gasparillo, Pointe-a-Pierre, Trinidad, who died on the 21st day of December, 2001, by PEARL STEADMAN of the same place, his lawful widow and relict;
- LETTERS OF ADMINISTRATION of the estate of RAMJASS BOODOO of Light Pole No. 5, Gowers Well Road, Fyzabad, Siparia, Trinidad, who died on the 1st day of October, 1996, by GAURAH BOODOO of the same place, his lawful widow and relict;
- LETTERS OF ADMINISTRATION of the estate of VERONICA BROWNE of 64, Main Road, Orange Valley, Couva, Trinidad, who died on the 5th day of November, 1999, by TREVOR BROWNE of 9, Rudin Lane, Belmont, Port-of-Spain, Trinidad, her lawful husband;
- PROBATE of the Will dated the 7th day of July, 1998, of JOHN SEEPERSAD of Light Pole No. 3, Joseph Brown Street, Flanagin Town, Montserrat, Trinidad, who died on the 13th day of June, 2002, by KENNETH SEEPERSAD of the same place, son of deceased, the sole executor named in the Will;
- LETTERS OF ADMINISTRATION of the estate of RAMDEO ROOPNARINE of 53, Orangefield Road, Chase Village, Chaguanas, Trinidad, who died on the 27th day of June, 2002, by RAMONA ROOPNARINE of the same place, his lawful widow and relict;
- LETTERS OF ADMINISTRATION of the estate of SANMAT ROOPNARINE otherwise SHANMATT BASANT otherwise SANMAT ROOPNARINE BOODOODASS of 1, John Peter Road, Charlieville, Chaguanas, Trinidad, who died on the 22nd day of May, 1999, by RUPNARINE BOODOODASS of the same place, her lawful husband;
- PROBATE of the Will dated the 1st day of November, 1993, of SHAFINA ALI otherwise SHAFFINA ALI of 8, Pro-Queen Street, Arima, Trinidad, who died on the 21st day of November, 1993, by AZAD ALI of the same place, son of deceased, the sole executor named in the Will;
- PROBATE of the Will dated the 11th day of July, 1988, of KHARTOON MOHAMMED otherwise KATOON of 19, Samlal Trace, Avocat Village, Fyzabad, Siparia, Trinidad, who died on the 14th day of August, 1988, by COORASHLA IFILL of 2, Anglican Street, Arima, Trinidad, granddaughter of deceased, the sole executrix named in the Will;

2151—Continued

PROBATE AND LETTERS OF ADMINISTRATION—CONTINUED

- LETTERS OF ADMINISTRATION of the estate of ZALEEL MOHAMMED of 5, Calcutta Road No. 3, McBean Village, Couva, Trinidad, who died on the 24th day of April, 2002, by FARIDAN MOHAMMED of the same place, his lawful widow and relict;
- LETTERS OF ADMINISTRATION of the estate of MATTHEW PATTERSON of 58A, Easterfield Road, Mason Hall, Tobago, who died on the 21st day of April, 2002, by LESLIE DILLANO PATTERSON of the same place, his son and one of the persons entitled to share in the estate;
- PROBATE of the Will dated the 11th day of October, 2001, of JOSEPH MASON of Light Pole No. 54, Moonan Road, Agua Santa Road, Waller Field, Arima, Trinidad, who died on the 27th day of May, 2002, by BRIAN PATRICK of the same place, grandson of deceased, the sole executor named in the Will;
- PROBATE of the Will dated the 11th day of February, 2000, of FRANCIS GEORGE VALADERE of 43, White Street, Five Rivers, Arouca, Tacarigua, Trinidad, who died on the 11th day of September, 2001, by JANET VALADERE of the same place, widow, relict of deceased, the sole executrix named in the Will;
- LETTERS OF ADMINISTRATION of the estate of TOTAH RAMANOOP of 42, Alma Street, Pointe-a-Pierre, Trinidad, who died on the 14th day of June, 2002, by CHANDRAWATEE RAMANOOP otherwise CHANDRAWATIE RAMANOOP of the same place, his lawful widow and relict;
- LETTERS OF ADMINISTRATION of the estate of MELISSA MOHAMMED of 14, St. Julien Road, Princes Town, Savana Grande, Trinidad, who died on the 21st day of November, 1999, by PERCY BICKAROO of 5, Woodland Road, Cedar Hill Village, Princes Town, Savana Grande, Trinidad, the lawfully appointed guardian of MARC ANTHONY MOHAMMED;
- PROBATE of the Will dated the 6th day of July, 1988, of RAMADHAR SEENATH of 108, Caparo Main Road, Caparo, Chaguanas, Trinidad, who died on the 20th day of January, 1991, by IVAN BISSOON of the same place, grandson of deceased, the sole executor named in the Will;
- LETTERS OF ADMINISTRATION of the estate of CURTIS ROBERTS of 3, Charles Street, Cantaro Village, Santa Cruz, St. Ann's, Trinidad, who died on the 3rd day of June, 2002, by JOEL BURNLEY-ROBERTS of the same place, his lawful widow and relict;
- LETTERS OF ADMINISTRATION of the estate of MARIE LEWIS of First Street, New Village, Point Fortin, La Brea, Trinidad, who died on the 4th day of January, 1991, by UNIEL LEWIS of the same place, her lawful husband;
- LETTERS OF ADMINISTRATION of the estate of MILLINGTON ALEXIS of 45, Strikers Village, Point Fortin, La Brea, Trinidad, who died on the 5th day of August, 1978, by MAUDRO ALEXIS of the same place, his lawful widow and relict;
- LETTERS OF ADMINISTRATION of the estate of THOMAS HANOOMANSINGH otherwise THOMAS WILLIAM HANOOMANSINGH otherwise RAMNARINE THOMAS HANUMANSINGH otherwise RAMNARINE THOMAS HANUMAN-SINGH of 1¹/₄ Mile Mark, Radix Village, Guayaguayare Road, Mayaro, Guayaguayare, Trinidad, who died on the 3rd day of March, 2000, by LALIE HANOMANSINGH of 67, Rodney Road, Endeavour Road, Chaguanas, Trinidad, his lawful widow and relict;
- LETTERS OF ADMINISTRATION of the estate of WINSTON JOHN of 25, St. John Street, Tunapuna, Tacarigua, Trinidad, who died on the 28th day of April, 2002, by EVARIST JOHN of the same place, his lawful widow and relict;
- LETTERS OF ADMINISTRATION of the estate of MERLE M. MOORE otherwise MERLE MOORE otherwise MERLE MARY MOORE of 38A, St. Barb's Road, Belmont, Port-of-Spain, Trinidad, who died on the 3rd day of October, 2001, by SANDRA MOORE-DAVIS of 30A, St. Barbs Road, Belmont, Port-of-Spain, Trinidad, her daughter and the only person entitled to the estate;
- PROBATE of the Will dated the 28th day of September, 1994, of CHRISTIANA ROBERTS of Tabaquite Road, Dades Trace, Rio Claro, Charuma, Trinidad, who died on the 1st day of June, 2002, by MADRI DOUGHLIN of 35C, St. Margaret's Old Road, Claxton Bay, Pointe-a-Pierre, Trinidad and CHRISTINE ROBERTS-HOUSEND of 27 Mile Mark, Tabaquite Road, Rio Claro, Charuma, Trinidad, daughters of deceased, the executrices named in the Will;
- PROBATE of the Will dated the 21st day of September, 2001, of RITA GILLIARD of 142, Lagoon Drive, Point d'Or, La Brea, Trinidad, who died on the 1st day of April, 2002, by KENRICK MITCHELL and ERICA MITCHELL, both of the same place, the executors named in the Will;

2151—Continued

PROBATE AND LETTERS OF ADMINISTRATION—CONTINUED

PROBATE of the Will dated the 2nd day of July, 2001, of WILMA PATRICIA HARRY otherwise WILMA HARRY otherwise PATRICIA HARRY of 15, Pemberton Street, La Romain, Naparima, Trinidad, who died on the 10th day of September, 2001, by RUBY JOHN of the same place, mother of deceased, the sole executrix named in the Will;

PROBATE of the Will dated the 18th day of June, 1977, of DARODAN BOCUS otherwise DARODAN BOCAS of Apartment 424, 4000, Don Mills Road, Don Mills, Metro, Toronto, Canada, who died on the 27th day of November, 1996, by ALISHAIR KHAN of 60, Southern Main Road, Marabella, Naparima, Trinidad, the sole executor named in the Will;

LETTERS OF ADMINISTRATION of the estate of ALEXANDER GRANT of Light Pole No. 12, Balantine Road, Five Rivers, Arouca, Tacarigua, Trinidad, who died on the 16th day of January, 2001, by CAROLINE GRANT of Light Pole No. 53, Chalis Trace, Mausica Road, d'Abadie, Arima, Trinidad, his lawful widow and relict;

PROBATE of the Will dated the 6th day of June, of FRANCIS SUGRIM of 30³/₄ Mile Mark, Tabaquite Road, Rio Claro, Charuma, Trinidad, who died on the 30th day of November, 1996, by RAWLE SUGRIM otherwise RAWLE POORAN SOOGRIM of the same place, son of deceased, the sole executor named in the Will;

PROBATE of the Will dated the 6th day of April, 1999, of STEVE SOLOMON of 14, Rose Avenue, Macoya Gardens, Tunapuna, Tacarigua, Trinidad, who died on the 13th day of October, 2001, by CHERIDAN WOODRUFFE and YVETTE WOODRUFFE, both of 20, Duncan Street, Port-of-Spain, Trinidad, the executors named in the Will;

LETTERS OF ADMINISTRATION of the estate of JOSEPH SIMMONS of 104, Craignish Road, Princes Town, Savana Grande, Trinidad, who died on the 10th day of June, 1973, by JOSEPHINE SIMMONS of the same place, his lawful daughter and one of the next of kin;

LETTERS OF ADMINISTRATION of the estate of DHANRAGEE TEELUCKSINGH of Bramble Trace, Cumuto, Tamana, Trinidad, who died on the 22nd day of October, 2001, by PUNETT TEELUCKSINGH of the same place, her lawful husband;

LETTERS OF ADMINISTRATION of the estate of OCTAVIA SMALL of Light Pole No. 66A, Riverside Drive, La Puerta Road, Diego Martin, Trinidad, who died on the 9th day of April, 2000, by EUGENIA SMALL of the same place, her daughter and one of the persons entitled to share in the estate;

PROBATE of the undated Will of 2000, of HAMIL AMEERALI of Flat 5, 59, Diego Martin Main Road, Diego Martin, Trinidad, who died on the 25th day of June, 2001, by DEVINDRA BOSE ROOPNARINESINGH of 6, Spring Drive, Valsayn Park, Valsayn, Tacarigua, Trinidad, grandson of deceased, one of the executors named in the Will;

LETTERS OF ADMINISTRATION of the estate of VASEWDEO RAMESSAR otherwise RAMESSAR VASEWDEO of 160, Balmain Village, Couva, Trinidad, who died on the 22nd day of May, 2001, by DEENA RAMESSAR of Southern Main Road, McBean, Couva, Trinidad, his lawful widow and relict;

LETTERS OF ADMINISTRATION of the estate of HARMIN SYBIL HORSFORD otherwise HERMIN SYBIL HORSFORD JAMES otherwise ERMINE JAMES of Trou Macaque Road, Laventille, St. Ann's, Trinidad, who died on the 9th day of September, 1994, by CECELIA JAMES of the same place, her lawful daughter and one of the next of kin;

LETTERS OF ADMINISTRATION of the estate of ROBERT MCKAY otherwise ROBERT ALEXANDER MCKAY otherwise O'REILLY MCKAY of 18, Kilgwyn Bay Road, Bon Accord, Tobago, who died on the 3rd day of August, 2000, by MARY VICTORY MCKAY of the same place, his lawful widow and relict;

LETTERS OF ADMINISTRATION of the estate of CLAUDE MCKAIN of 1, Village Street, Mt. St. George, Tobago, who died on the 29th day of June, 2001, by WINFIELD MCKAIN of the same place, his lawful son and one of the next of kin;

and unless Caveat is lodged within twenty-one days from the date of this advertisement with the Registrar of the Supreme Court of Judicature, through whom the above-mentioned applications have been made, Probate and/or Letters of Administration, as the case may be, in respect of the said applications, will be granted accordingly.

Dated the 24th day of October, 2002.

E. A. PETERSEN
Registrar of the Supreme Court of Judicature

2152

CENTRAL BANK OF TRINIDAD AND TOBAGO

WEEKLY STATEMENT OF ACCOUNT AS AT 16TH OCTOBER, 2002

<i>Previous Week</i> \$000	<i>Assets</i>	<i>PROVISIONAL</i> <i>This Week</i> \$000
	External Assets:	
12,862,109	Balances, Investments, etc.	12,704,408
25,402	Gold Subscriptions to I.M.F.	25,402
1,827	I.M.F.—S.D.R. Holdings	1,827
-----		-----
12,889,338		12,731,637
	Trinidad and Tobago Government Securities:	
54	Treasury Bills (Face Value)	54
16,463	Marketable Securities	16,463
-----		-----
16,517		16,517
	Other Assets:	
376,039	Trinidad and Tobago Dollar Securities	376,006
283,524	Advances to Government Authorities	283,524
1,907,737	Other Assets	1,923,925
-----		-----
2,567,300		2,583,455
263,486	Fixed Assets:	264,720
-----		-----
15,736,641		15,596,329
=====		=====
	<i>Liabilities and Capital Account</i>	
	Currency in Circulation:	
1,618,338	Notes	1,593,797
81,708	Coins	81,795
-----		-----
1,700,046		1,675,592
	Demand Liabilities:	
3,020,024	Commercial Banks	2,933,769
518,277	Financial Institutions (Non-Banking)	519,027
4,626,320	Government and Governmental Organisations	4,623,784
22,243	International Organisations	22,244
261,338	Foreign Currency	258,443
240,890	Other	290,762
-----		-----
8,689,092		8,648,029
	Other Liabilities:	
376,422	Government S.D.R. Allocations	376,422
3,064,774	Other Liabilities	2,978,476
1,721,521	Specific Provisions	1,733,024
-----		-----
5,162,717		5,087,922
	Capital and Reserves:	
100,000	Capital Paid-up	100,000
84,786	General Reserve Fund	84,786
-----		-----
184,786		184,786
-----		-----
15,736,641		15,596,329
=====		=====

NOTES:

1. This Statement as taken from the books of the Central Bank does not include accruals on balances and investments (excluding Trinidad and Tobago Treasury Bills) from 1st October, 2002.

2. This Statement does not include end of year adjustments for 2001/2002.

F. MOHAMMED
Manager,
Finance and Accounting

2153

RESULTS OF NATIONAL LOTTERY DRAW NO. 965

NOTICE is hereby given under the provisions of the National Lotteries Regulations, 1969, made in accordance with section 30 of the National Lotteries Act, Chap. 21:04 that the numbers of the winning tickets in Lottery No. 965 are as follows:

First Prize	52644
Second Prize	55755
Third Prize	60464
Fourth Prize	06544
Fifth Prize	24751
Sixth Prize	62737
Seventh Prize	45079
Eighth Prize	04374
Ninth Prize	30693
Tenth Prize	10518

Dated this 21st day of October, 2002.

By Order of the National Lotteries Control Board.

P. PIERRE-JOSEPH
Acting Secretary to the Board

2154

NATIONAL LOTTERY DRAW NO. 966

NOTICE is hereby given with lawful authority under the provisions of the National Lotteries Control Regulations, 1969, made in accordance with section 30 of the National Lotteries Act, Chap. 21:04, the National Lotteries Control Board has appointed Saturday 26th October, 2002, at 5.00 o'clock in the evening at CCN TV6, Express House, 35-37, Independence Square, Port-of-Spain, as the day, hour and venue at which Draw No. 966 of the Classic Lottery of Trinidad and Tobago shall be held to determine the numbers of the winning tickets.

The number of tickets issued is 70,000 with serial numbers ranging from 00000 to 69999 at the cost of \$10.00 per ticket. Each ticket is made up of 5 fractions numbered from 1 to 5, each having the value being equivalent in cost to 1/5th of a ticket, i.e., \$2.00.

HOLDERS OF WINNING TICKETS

First Prize—\$100,000	2 Approximate First Prizes—\$800 each
Second Prize—\$30,000	2 Approximate Second Prizes—\$700 each
Third Prize—\$15,000	2 Approximate Third Prizes—\$600 each
Fourth Prize—\$10,000	2 Approximate Fourth Prizes—\$500 each
Fifth Prize—\$7,500	2 Approximate Fifth Prizes—\$400 each
Sixth Prize—\$5,000	2 Approximate Sixth Prizes—\$200 each
Seventh Prize—\$3,000	2 Approximate Seventh Prizes—\$200 each
Eighth Prize—\$2,000	2 Approximate Eighth Prizes—\$200 each
Ninth Prize—\$1,500	2 Approximate Ninth Prizes—\$200 each
Tenth Prize—\$1,000	2 Approximate Tenth Prizes—\$200 each

99 Prizes for holders of tickets with first 3 digits of 1st Prize—\$50 each

99 Prizes for holders of tickets with first 3 digits of 2nd Prize—\$50 each

99 Prizes for holders of tickets with first 3 digits of 3rd Prize—\$50 each

99 Prizes for holders of tickets with first 3 digits of 4th Prize—\$50 each

99 Prizes for holders of tickets with first 3 digits of 5th Prize—\$50 each

699 Prizes for holders of tickets with last 2 digits of 1st Prize—\$25 each

699 Prizes for holders of tickets with last 2 digits of 2nd Prize—\$25 each

699 Prizes for holders of tickets with last 2 digits of 3rd Prize—\$25 each

699 Prizes for holders of tickets with last 2 digits of 4th Prize—\$25 each

699 Prizes for holders of tickets with last 2 digits of 5th Prize—\$25 each

2154—Continued

NATIONAL LOTTERY DRAW NO. 966—CONTINUED

HOLDERS OF WINNING TICKETS—Continued

699 Prizes for holders of tickets with last 2 digits of 6th Prize—\$25 each
 699 Prizes for holders of tickets with last 2 digits of 7th Prize—\$25 each
 699 Prizes for holders of tickets with last 2 digits of 8th Prize—\$25 each
 699 Prizes for holders of tickets with last 2 digits of 9th Prize—\$25 each
 699 Prizes for holders of tickets with last 2 digits of 10th Prize—\$25 each

SELLERS' PRIZES

First Prize—\$3,000	2 Approximate First Prizes—\$100 each
Second Prize—\$2,000	2 Approximate Second Prizes—\$100 each
Third Prize—\$1,000	2 Approximate Third Prizes—\$100 each
Fourth Prize—\$500	2 Approximate Fourth Prizes—\$100 each
Fifth Prize—\$400	2 Approximate Fifth Prizes—\$100 each
Sixth Prize—\$200	2 Approximate Sixth Prizes—\$100 each
Seventh Prize—\$200	2 Approximate Seventh Prizes—\$100 each
Eighth Prize—\$200	2 Approximate Eighth Prizes—\$100 each
Ninth Prize—\$200	2 Approximate Ninth Prizes—\$100 each
Tenth Prize—\$200	2 Approximate Tenth Prizes—\$100 each

99 First 3 digits of 1st Prize—\$50 each
 99 First 3 digits of 2nd Prize—\$50 each
 99 First 3 digits of 3rd Prize—\$50 each
 99 First 3 digits of 4th Prize—\$50 each
 99 First 3 digits of 5th Prize—\$50 each

69 Last 3 digits of 1st Prize—\$40 each
 69 Last 3 digits of 2nd Prize—\$40 each
 69 Last 3 digits of 3rd Prize—\$40 each
 69 Last 3 digits of 4th Prize—\$40 each
 69 Last 3 digits of 5th Prize—\$40 each

AGENTS' PRIZES

First Prize—\$1,000	2 Approximate First Prizes—\$30 each
Second Prize—\$750	2 Approximate Second Prizes—\$30 each
Third Prize—\$500	2 Approximate Third Prizes—\$30 each
Fourth Prize—\$350	2 Approximate Fourth Prizes—\$30 each
Fifth Prize—\$300	2 Approximate Fifth Prizes—\$30 each
Sixth Prize—\$125	2 Approximate Sixth Prizes—\$30 each
Seventh Prize—\$125	2 Approximate Seventh Prizes—\$30 each
Eighth Prize—\$125	2 Approximate Eighth Prizes—\$30 each
Ninth Prize—\$125	2 Approximate Ninth Prizes—\$30 each
Tenth Prize—\$125	2 Approximate Tenth Prizes—\$30 each

Prizes may be claimed at the Board's Offices during the hours of business shown hereunder:

No. 119–121 Duke Street, Port-of-Spain—Mondays to Fridays—9.00 a.m. to 3.00 p.m.

No. 73 Mucurapo Street, San Fernando—Mondays and Wednesdays—9.00 a.m. to 12.00 noon and 1.00 p.m. to 2.00 p.m.

Multipurpose Facility, Sangsters Hill, Scarborough, Tobago—Tuesdays—9.00 a.m. to 12.00 noon and 1.00 p.m. to 2.30 p.m.

The public is invited to witness the Draw subject to the availability of space in the Studio at CCN TV6, Express House, 35–37, Independence Square, Port-of-Spain.

Dated this 19th day of October, 2002.

By Order of the National Lotteries Control Board.

P. PIERRE-JOSEPH
Acting Secretary to the Board

2155

FORM NO. 3 - THE PATENTS ACT.

<p>(19) Intellectual Property Office Trinidad and Tobago</p> 	<p>(11) Publication Number: TT/P/2002/00012</p> <p>(45) Publication Date: Thursday 24th October, 2002</p> <p>(51) IPC: (6) E21B</p>
---	--

(12) **PATENT**

<p>(21) Application Number: TT/A/1998/00052</p> <p>(22) Filing Date: 17 July 1998</p> <p>(31) Priority Number: 08/902,474</p> <p>(32) Priority Date: 29 July 1997</p> <p>(33) Priority Country: UNITED STATES OF AMERICA</p>	<p>(73) Owner(s): EXXONMOBIL CORPORATION, 3225 Gallows Road, Fairfax, Virginia 22037, U.S.A.</p> <p>(72) Inventor(s): Lloyd Garner Jones, 2029 Eddtide Lane, Dallas, TX 75224, Dallas County, U.S.A.</p> <p>(74) Agent: J. D. Sellier & Co., 129/131 Abercromby Street, Port of Spain, Trinidad, W.I.</p>
---	--

(54) **Title: ALTERNATE-FLOW WELL TOOL HAVING AN INTERNAL SHUNT TUBE**

(57) **Abstract: A gravel-pack, well screen having an internal shunt tube positioned inside the screen, for delivering gravel slurry to different levels within the well annulus during a gravel pack operation. The screen is comprised of one or more joints with each joint being comprised of a base pipe having a screen section therein. The internal shunt extends substantially throughout the length of the base pipe. Bolts, each having a passage therethrough, provide fluid passages between the exterior of the screen and the internal shunt tube near either end of the base pipe. During operation, slurry enters the internal shunt tube through the uppermost bolt and exits into the annulus through the passages in the lower bolts to distribute gravel to different levels of the annulus.**

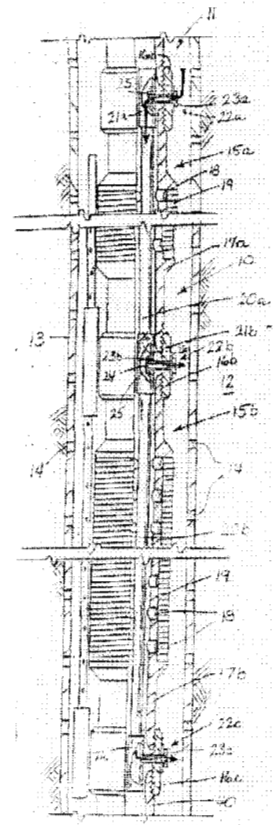

2156

FORM NO. 3 - THE PATENTS ACT.

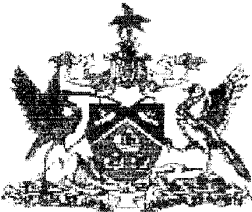
<p>(19) Intellectual Property Office Trinidad and Tobago</p> 	<p>(11) Publication Number: TT/P/2002/00013</p> <p>(45) Publication Date: Thursday 24th October, 2002</p> <p>(51) IPC: (6) E21B</p>
---	--

(12) **PATENT**

<p>(21) Application Number: TT/A/1999/00044</p> <p>(22) Filing Date: 4 December 1997</p> <p>(31) Priority Number: 08/759,542</p> <p>(32) Priority Date: 5 December 1996</p> <p>(33) Priority Country: UNITED STATES OF AMERICA</p>	<p>(73) Owner(s): ABB VETCO GRAY INC., 10777 North-west Freeway, Houston, TX 77252, U.S.A.</p> <p>(72) Inventor(s): Charles D. Bridges, 15318 Chestnut Falls Drive, Cypress, TX 77429, U.S.A.</p> <p>(74) Agent: J. D. Sellier & Co., 129/131 Abercromby Street, Port of Spain, Trinidad, W.I.</p>
---	---

(54) **Title: SINGLE RISER WITH TWO WELLHEADS.**

(57) **Abstract:** A guidance system comprising two guide tubes (13,15) are lowered into a well with a conductor (11). The guide tubes (13,15) are connected together by partitions (17) which divide the conductor into two halves. Each partition (17) comprises two symmetrical half sections facing in opposite directions. The operator lowers a string of drill pipe (25) into the conductor to drill a first smaller diameter well at the bottom of the conductor. After drilling to the desired depth, the operator runs a first string of casing (29) down the conductor and through the new well bore. The casing (29, 31) is located on one side of each partition (17) and cemented in place. The operator then lowers the drill pipe down the other side of the partitions (17) and repeats the drilling and casing (31) of a second well.

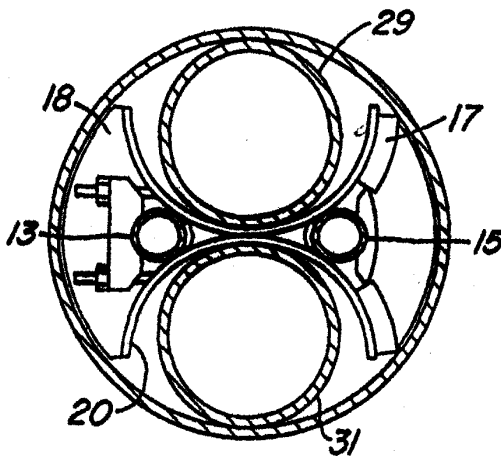

2157

FORM NO. 3 - THE PATENTS ACT.

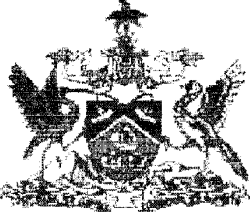
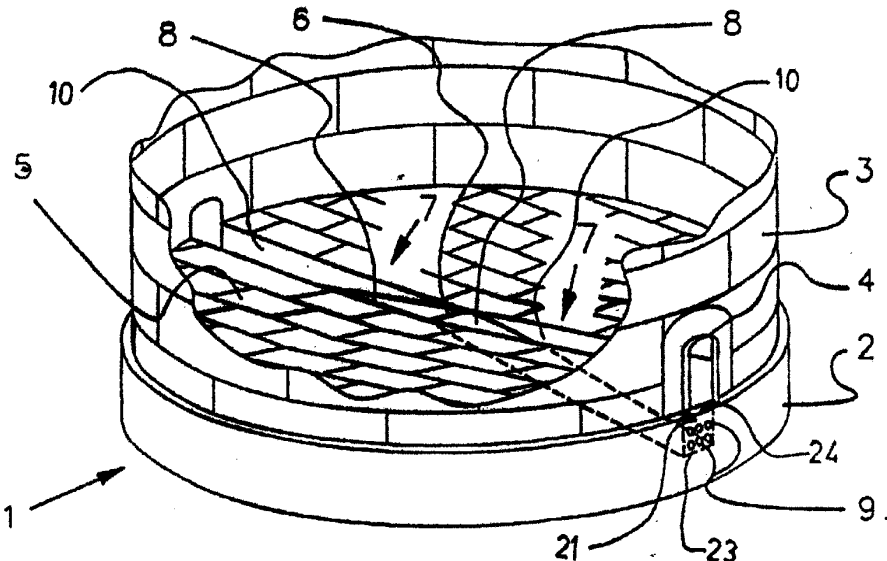
<p>(19) Intellectual Property Office Trinidad and Tobago</p> 	<p>(11) Publication Number: TT/P/2002/00014</p> <p>(45) Publication Date: Thursday 24th October, 2002</p> <p>(51) IPC: (6) B65D</p>
<p>(12) PATENT</p>	
<p>(21) Application Number: TT/A/1999/00004</p> <p>(22) Filing Date: 19 June 1997</p> <p>(31) Priority Number: PI 9603160-3</p> <p>(32) Priority Date: 26 July 1996</p> <p>(33) Priority Country: BRAZIL</p>	<p>(73) Owner(s): PETRÓLEO BRASILEIRO S.A. – PETROBRAS, Avenida República do Chile nº 65, Rio de Janeiro, Brazil.</p> <p>(72) Inventor(s): WITTER Aldyr (deceased), Avenida Sao Borja, 1200, São Leopoldo, RS, Brazil CEP: 93032-000</p> <p>(74) Agent: J. D. Sellier & Co., 129/131 Abercromby Street, Port of Spain, Trinidad, W.I.</p>
<p>(54) Title: TANK FOR STORING LIQUID PRODUCTS.</p>	
<p>(57) Abstract: A tank for storing liquid products, particularly a large capacity tank (1), comprises a bottom (5), whose centre (6), is at a level below the level of the edge of the bottom. Drainage channels (7), consisting of a ramp (8), as floor with lateral plates (10), as sides bring the undesirable materials to the edge of the tank where they can be drained out of the tank through drainage tubes.</p>	
	

2158

FORM NO. 3 - THE PATENTS ACT.

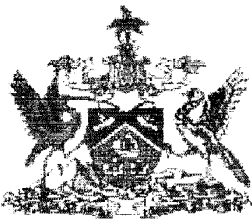
<p>(19) Intellectual Property Office Trinidad and Tobago</p> 	<p>(11) Publication Number: TT/P/2002/00015</p> <p>(45) Publication Date: Thursday 24th October, 2002</p> <p>(51) IPC: (6) C07C</p>
<p>(12) PATENT</p>	
<p>(21) Application Number: TT/A/1999/00117</p> <p>(22) Filing Date: 15 May 1998</p> <p>(31) Priority Number: 08/870,120</p> <p>(32) Priority Date: 3 June 1997</p> <p>(33) Priority Country: UNITED STATES OF AMERICA</p>	<p>(73) Owner(s): CELANESE INTERNATIONAL CORPORATION, 1601 West LBJ Freeway, Dallas, Texas, 75234, United States of America.</p> <p>(72) Inventor(s): IOAN NICOLAU, Apartment 2902, 6717 Everhart, Corpus Christi, TX 78413, U.S.A.; PHILIP M. COLLING, 609 Barracuda Place, Corpus Christi, TX 78411, U.S.A.; JERRY A. BROUSSARD, 7505 Venice Drive, Corpus Christi, TX 78413, U.S.A.</p> <p>(74) Agent: M. Hamel-Smith & Co., 19 St. Vincent Street, Port of Spain, Trinidad, W.I.</p>
<p>(54) Title: VINYL ACETATE PROCESS UTILIZING A PALLADIUM-GOLD-COPPER CATALYST.</p>	
<p>(57) Abstract: A process is disclosed for the production of vinyl acetate by reaction of ethylene, oxygen and acetic acid as reactants comprising contacting said reactants and a non-halogen containing copper compound with a catalyst comprising a porous support on the porous surfaces of which is deposited catalytically effective amounts of metallic palladium, gold and copper. During the process to prepare vinyl acetate, a stream of alkali metal acetate is preferably passed over the catalyst. The process results in higher vinyl acetate selectivity and productivity due to lower CO₂ selectivity during the life of the catalyst.</p>	

2159

FORM NO. 3 - THE PATENTS ACT.

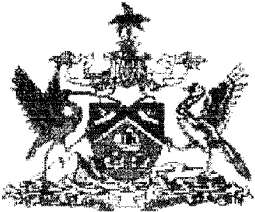
<p>(19) Intellectual Property Office Trinidad and Tobago</p> 	<p>(11) Publication Number: TT/P/2002/00016</p> <p>(45) Publication Date: Thursday 24th October, 2002</p> <p>(51) IPC: (6) C07C</p>
<p>(12) PATENT</p>	
<p>(21) Application Number: TT/A/1999/00055</p> <p>(22) Filing Date: 11 December 1997</p> <p>(31) Priority Number: 96203538.2</p> <p>(32) Priority Date: 13 December 1996</p> <p>(33) Priority Country: NL</p>	<p>(73) Owner(s): SHELL INTERNATIONALE RESEARCH MAATSHCAPPIJ B.V., Carel van Bylandtlaan 30, 2596 HR The Hague, The Netherlands.</p> <p>(72) Inventor(s): Jacobus Johannes Cornelis Geerlings, Badhuisweg 3, 1031 CM AMSTERDAM, The Netherlands; Arend Hoek, Badhuisweg 3, CM AMSTERDAM, The Netherlands; Hans Michiel Huisman, Badhuisweg 3, 1031 CM AMSTERDAM, The Netherlands; Peter William Lednor, Badhuisweg 3, 1031 CM AMSTERDAM, The Netherlands.</p> <p>(73) Agent: Fitzwilliam, Stone, Furness-Smith & Morgan, 36 Pembroke Street, Port of Spain, Trinidad, W.I.</p>
<p>(54) Title: PROCESS FOR THE PREPARATION OF HYDROCARBONS.</p>	
<p>(57) Abstract: The present invention relates to a process for the preparation of hydrocarbons by catalytic reaction of carbon monoxide with hydrogen in which reaction a feed comprising hydrogen and carbon monoxide is contacted at elevated temperature and pressure with a catalyst comprising cobalt and manganese in which catalyst the cobalt/manganese molar ratio is between 14:1 and 7:1 and the GHSV is at least 1600 N1/1/h. Preferably the cobalt/manganese molar ratio is between 13:1 and 9:1 and the GHSV is between 2700 and 25,000 N1/1/h. The reaction is especially carried out in a slurry phase regime.</p>	

2160

FORM NO. 3 - THE PATENTS ACT.

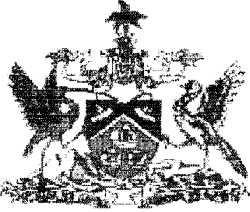
<p>(19) Intellectual Property Office Trinidad and Tobago</p> 	<p>(11) Publication Number: TT/P/2002/00017</p> <p>(45) Publication Date: Thursday 24th October, 2002</p> <p>(51) IPC: (6) A23B</p>
---	--

(12) **PATENT**

<p>(21) Application Number: TT/A/2000/00068</p> <p>(22) Filing Date: 4 August 1998</p> <p>(31) Priority Number: 08/980,392</p> <p>(32) Priority Date: 28 November 1997</p> <p>(33) Priority Country: UNITED STATES OF AMERICA</p>	<p>(72) Owner(s): WILLIAM R. KOWALSKI, 2161 Kalia Road, No. 306, Honolulu, Hawaii 96815.</p> <p>(72) Inventor(s):</p> <p>(74) Agent: J. D. Sellier & Co., 129/131 Abercromby Street, Port of Spain, Trinidad, W.I.</p>
--	---

(54) **Title: PROCESS FOR MANUFACTURING TASTELESS SUPER PURIFIED SMOKE FOR TREATING SEAFOOD TO BE FROZEN AND THAWED.**

(57) **Abstract:** Tasteless super-purified smoke is manufactured to treat seafood and meat to preserve the freshness, color, texture, and natural flavor, particularly after the food is frozen and thawed. The smoke is generated by burning an organic smoking material at preferably 500 to 800 degrees F. (260 to 427 degrees C.) in a smoke generator (1). It is then passed through a precipitation filtering tower (2) comprised of filters of ice, cloth, and activated carbon to remove taste imparting, and carcinogenic, particulates and vapors. The super-purified smoke is then stored and aged in a temporary pressure pot (3) or in canisters for treatment at the same time or at another place and time. The super-purified smoke is used to treat seafood or meat in plastic bags at temperatures between its variable freezing point 46 degrees F. (7.8 degrees C). for twelve to forty-eight hours, or until the desired effect is achieved. The product is then frozen, stored for up to one year, and quick or slow thawed with little degradation of the treated seafood or meat.

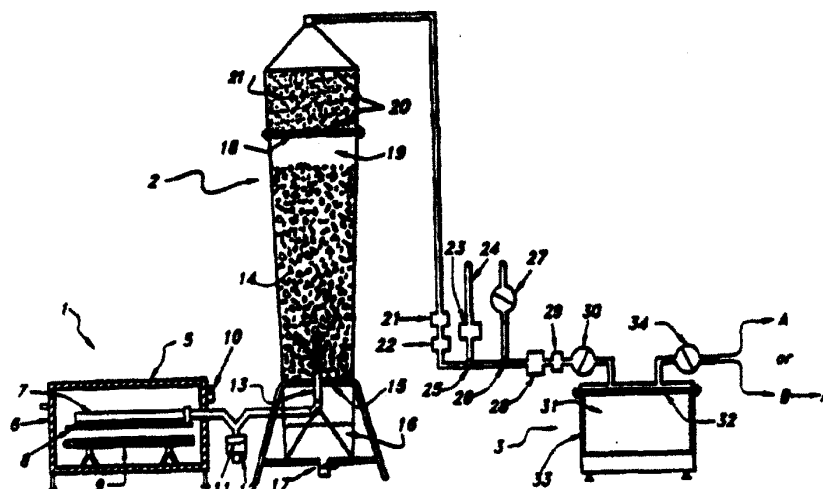

2161

PROPOSALS FOR CONSULTING SERVICES FOR THE DESIGN OF A SUPPLY/SUBSTITUTE TEACHER SYSTEM FOR THE MINISTRY OF EDUCATION UNDER THE SECONDARY EDUCATION MODERNIZATION PROGRAMME (SEMP)—IDB LOAN NO. 1180/OC-TT

THE GOVERNMENT OF THE REPUBLIC OF TRINIDAD AND TOBAGO (GORTT) through the Ministry of Education (MOE) has accessed loan funding from the Inter-American Development Bank (IDB) for a Secondary Education Modernization Programme (SEMP) (IDB Loan No. 1180/OC-TT), the goal of which is to modernize the secondary education sector in Trinidad and Tobago. One of the major components of the Programme is the Institutional Strengthening which is geared towards embracing management and operational efficiency of the Ministry of Education. Several training projects have been planned with respect to the implementation of this component, inclusive of training in manpower planning for the selected staff and development of a system of supply teachers for the human resource department of the Ministry of Education.

In this regard, proposals are invited from interested individuals to design, develop and deliver a supply/substitute teacher system that will form part of the human resource management capabilities at the Ministry level and at the School level.

The terms of reference and other related documents may be obtained during normal working hours at the Central Tenders Board (CTB), 116, Frederick Street, Port-of-Spain. Any further technical information may be obtained from—

Ms. Cherrie Ann Joseph
Assistant Programme Co-ordinator
Institutional Strengthening
SEMP Co-ordinating Unit
MTS Plaza
Arranguez
Telephone Number 675-9746 Ext. 222
Fax No: 675-9739, 7788.
E-Mail: sempcu@tsstt.net.tt

Ms. Jennifer Andall
Human Resource Specialist
Institutional Strengthening
SEMP Co-ordinating Unit
MTS Plaza
Arranguez
Telephone Number 675-9739, Ext. 230

Proposals must be accompanied by valid Income Tax and Value Added Tax Clearance Certificates.

Proposals will be evaluated in accordance with the following criteria:

- (a) Academic Qualifications.
- (b) Knowledge and understanding of the job as indicated by proposed outline and methodology of undertaking the assignment.
- (c) Work experience in projects of comparable size, complexity and technical speciality.
- (d) Work experience in a similar country and/or similar Project.
- (e) Special skills and competencies.

Proposers are requested to hold their offer valid for ninety (90) days from the date of the opening of proposal.

One (1) original and five (5) copies of the technical and financial proposals respectively should be placed in separately sealed envelopes clearly marked: "Proposals for consulting services for the design of a Supply/Substitute Teacher System for the Ministry of Education under the Secondary Education Modernization Programme (SEMP)—IDB Loan 1180/OC-TT".

Envelopes must be addressed to—

Chairman
Central Tenders Board
116, Frederick Street
Port-of-Spain

and deposited in the Brown Tender Box located on the first floor of the Board's Office not later than 1.00 p.m. on Thursday 28th November, 2002. Technical proposal will be publicly opened shortly afterwards. The tenderer or representative may be present at the opening.

Late proposals will not be accepted under any circumstances.

The Central Tenders Board reserves the right to cancel the present notice in its entirety or even partially without defraying the cost incurred by any individual in submitting a proposal.

M. MARCANO
Chairman,
Central Tenders Board

15 October, 2002.